

**NYHED**  
Vi tilbyder klargøring af DIN maskine



# UNIVERSAL AFPUDSERE

Prisliste 1. juli 2021

**MODEL JOLLY**



**JOLLY 210**  
Til græsarealer, sportspladser m.v.

**Standardudstyr:**  
Single speed gearbox 540 rpm  
Universal 3-punkt hitch cat. I (210 = cat. II)  
Juster- og drejbare hjul  
Kraftoverføringsaksel

**Ekstra udstyr:**  
Mulch udstyr - gælder ikke 210 kr. 3.500  
Tillæg frontmontering, 1000 rpm kr. 1.700  
Tillæg frontmontering, 2000 rpm kr. 3.700  
Klargøring kr. 650  
- gælder ikke 210  
Hydraulisk træk *Forhør*

Model		Arb.bredde	Totalbredde					Pris		
	kW	HP	cm	cm	cm	rpm	stk.	kg	ex. moms	
JOLLY 120	10-30	14-40	120	125	60	60	540	3	165	16.600
JOLLY 150	17-30	23-40	150	155	75	75	540	3	190	18.700
JOLLY 180	24-30	32-40	180	185	90	90	540	3	225	20.700
JOLLY 210	26-37	35-50	210	215	105	105	540	3x2	365	24.900

**MODEL BIRBA**

Vendbar  
Afklip op til Ø2 cm



Til Mini-traktorer

**Standardudstyr:**  
Gearbox 540 rpm med friløb  
Universal 3-punkt hitch cat. I  
Selvrensende justerbar rullevalse  
Slæbesko  
Kraftoverføringsaksel  
Hammerkniv 21

**Ekstra udstyr:**  
Klargøring kr. 650  
Hydraulisk træk *Forhør*

Model		Arb.bredde	Totalbredde					Pris		
	kW	HP	cm	cm	cm	rpm	stk.	kg	ex. moms	
BIRBA 95	7-30	10-40	95	113	47,5	47,5	540	20	180	24.600
BIRBA 115	11-30	15-40	115	133	57,5	57,5	540	24	200	25.300
BIRBA 135	15-30	20-40	135	153	67,5	67,5	540	28	220	25.900
BIRBA 155	18-30	25-40	155	173	77,5	77,5	540	32	240	26.800

## MODEL **FURBA** VENDBAR

Afklip op til Ø2 cm







### Standardudstyr:

Gearbox 540 rpm med friløb  
 Universal 3-punkt hitch cat. I  
 Justerbar rullevalse Ø140  
 Slæbesko  
 Kraftoverføringsaksel  
 Hammerkniv 21  
 Parallel, mekanisk sideregulering

### Ekstra udstyr:

Tillæg for hydraulisk forskydning kr. 2.900  
 Tillæg for frontmontering, 1000 rpm kr. 1.900  
 Klargøring kr. 450  
 Hydraulisk træk Forhør

Model		Arb.bredde	Totalbredde					Pris	
	kW	HP	cm	cm	cm	rpm	stk.	kg	ex. moms
<b>FURBA 100</b>	7-30	10-40	95	113	60 40	540	20	195	25.200
<b>FURBA 120</b>	11-30	15-40	115	133	75 45	540	24	214	26.500
<b>FURBA 140</b>	15-30	20-40	135	153	84 44	540	28	236	27.700
<b>FURBA 160</b>	26-30	35-40	155	173	84 44	540	32	250	28.800
<b>FURBA 180</b>	30-30	40-40	170	188	84 44	540	36	258	29.900

## MODEL **BARBI**

Afklip op til Ø4 cm







### Standardudstyr:

Gearbox 540 rpm med friløb  
 Universal 3-punkt hitch cat. I  
 Selvrensende, justerbar rullevalse Ø140  
 Modskær  
 Kraftoverføringsaksel  
 Hammerkniv 20  
 Mekanisk sideregulering

### Ekstra udstyr:

Slæbesko, sæt 99600157 kr. 1.600  
 Tillæg for hydraulisk sideforskydning kr. 2.900  
 Klargøring kr. 550

Model		Arb.bredde	Totalbredde					Pris	
	kW	HP	cm	cm	cm	rpm	stk.	kg	ex. moms
<b>BARBI 100</b>	14-34	20-45	100	113	60 40	540	14	262	28.100
<b>BARBI 120</b>	19-34	25-45	120	133	75 45	540	16	283	28.800
<b>BARBI 140</b>	22-34	30-45	140	155	84 44	540	18	310	29.700
<b>BARBI 160</b>	26-34	35-45	160	175	84 44	540	22	326	30.500
<b>BARBI 180</b>	29-34	40-45	175	190	84 44	540	24	344	31.150

## MODEL BRAVA

Afklip op til Ø6 cm



### Standardudstyr:

Gearbox 540 rpm med friløb  
 Universal 3-punkt hitch cat. I  
 Flyt- og justerbar rullevalse Ø168  
 Modskær  
 Kraftoverføringsaksel  
 Hammerkniv 08  
 Parallel, mekanisk sideregulering, gælder ikke 120

### Ekstra udstyr:

Slæbesko, sæt 99600037 kr. 1.600  
 Faste frontmonterede hjul kr. 5.300  
 Tillæg for hydraulisk sideforskydning kr. 2.900  
 Tillæg cat. II, 3-punkt kr. 1.250  
 Klargøring kr. 550

Model		Arb.bredde	Totalbredde					Pris		
Fast	kW	HP	cm	cm	cm	rpm	stk.	kg	ex. moms	
<b>BRAVA 120</b>	19-60	25-80	115	133	57,5	57,5	540	12	361	32.500
<i>Forskydelig</i>										
<b>BRAVA 140</b>	22-60	30-80	135	153	70 41	65 94	540	14	435	37.200
<b>BRAVA 160</b>	26-60	35-80	155	173	80 40	75 115	540	16	467	39.400
<b>BRAVA 180</b>	29-60	40-80	173	188	85 45	88 128	540	20	490	41.700
<b>BRAVA 200</b>	33-60	45-80	195	208	98 58	96 136	540	22	528	43.900
<b>BRAVA 230</b>	37-60	50-80	230	245	123 83	107 147	540	26	620	44.700
<b>BRAVA 250</b>	40-60	55-80	257	270	137 97	120 160	540	28	650	47.100

## MODEL BELLA

Mulighed for frontmontering  
 Afklip op til Ø6 cm



Dobbelt hitch med gennemgående PTO.

### Standardudstyr:

Gearbox 540 rpm med friløb  
 Universal 3-punkt hitch cat. I  
 Modskær  
 Justerbar rullevalse Ø168  
 Kraftoverføringsaksel  
 Hammerkniv 08  
 Parallel, mekanisk sideregulering

### Ekstra udstyr:

Slæbesko, sæt 99600037 kr. 1.600  
 Tillæg hydraulisk sideforskydning kr. 2.900  
 Tillæg frontmontering, 1000 rpm kr. 2.800  
 Tillæg frontmontering, 540 rpm kr. 3.450  
 Tillæg cat. II, 3-punkt kr. 1.250  
 Fronthjul, sæt, drejbar kr. 5.700  
 Klargøring kr. 450

Model		Arb.bredde	Totalbredde					Pris		
	kW	HP	cm	cm	cm	rpm	stk.	kg	ex. moms	
<b>BL 135</b>	22-59	30-80	135	150	82 42	53 93	540	14	400	36.500
<b>BL 155</b>	26-59	35-80	155	170	82 42	73 113	540	16	430	38.900
<b>BL 170</b>	30-59	40-80	170	185	96 56	74 114	540	20	470	40.900
<b>BL 190</b>	33-59	45-80	190	205	96 56	94 134	540	22	500	43.200
<b>BL 210</b>	36-59	50-80	210	225	96 56	114 154	540	24	530	45.600

## MODEL CORAZZA

Afklip op til Ø10 cm









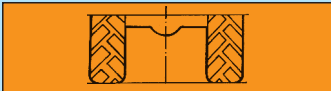

### Standardudstyr:

Gearbox 540 rpm med friløb  
 Universal 3-punkt hitch cat. II  
 Udvendig remjustering  
 Modskær  
 Flyt- og justerbar rullevalse Ø168  
 Kraftoverføringsaksel  
 Hammerkniv 14  
 Parallel, mekanisk sideregulering

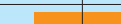
### Ekstra udstyr:

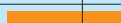
Slæbesko, sæt 99600961 kr. 1.900  
 Tillæg hydraulisk sideforskydning kr. 3.200  
 Tillæg styrehjul i stedet for rullevalse kr. 6.000  
 Dobbelt svøb med ekstra modskær kr. 4.450  
 Tillæg HD-rotor kr. 3.450  
 Klargøring kr. 450

Model		Arb.bredde		Totalbredde						Pris	
		cm	cm	cm	cm						cm
CR 155	29-58	40-80	155	170	81 46		74 109	540	16	550	43.900
CR 170	33-58	45-80	170	185	84 49		86 121	540	18	572	45.900
CR 190	38-58	50-80	190	205	90 55		91 135	540	20	608	49.200
CR 210	40-58	55-80	210	225	99 55		111 155	540	22	645	52.400
CR 230	44-58	60-80	230	245	115 71		115 159	540	24	680	55.400

## MODEL TIGRE

Afklip op til Ø12 cm









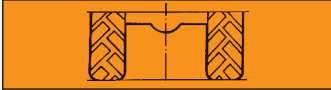

### Standardudstyr:

Gearbox 540 rpm med friløb  
 Universal 3-punkt hitch cat. II  
 Udvendig remjustering  
 Dobbelt modskær  
 Dobbelt pladet svøb  
 Flyt og justerbar rullevalse Ø168  
 Kraftoverføringsaksel  
 Hammerkniv 14  
 Parallel, mekanisk sideregulering

### Ekstra udstyr:

Slæbesko, sæt 99500A10 kr. 1.600  
 Tillæg for hydraulisk sideforskydning kr. 2.900  
 Tillæg styrehjul i stedet for rullevalse kr. 5.550  
 Tillæg HD-rotor kr. 5.650  
 Lys og advarselskit kr. 2.850  
 Klargøring kr. 450

Model		Arb.bredde		Totalbredde						Pris	
		cm	cm	cm	cm						cm
TIGRE 210	40-102	55-140	210	233	119 69		91 141	540	16	775	56.400
TIGRE 230	44-102	60-140	226	249	130 80		96 146	540	20	810	58.400
TIGRE 250	47-102	65-140	257	280	144 94		113 163	540	20	880	60.300
TIGRE 280	51-102	70-140	276	299	159 109		117 167	540	24	925	62.400
TIGRE 300	58-102	90-140	298	321	159 109		139 189	540	24	955	65.100

## MODEL BISONTE

Afklip op til Ø12 cm



Bisonte i kombination med Giraffa XXL

Til front- og/eller bagmontering.

### Standardudstyr:

Gearbox 1000 rpm med friløb  
Dobbelt 3-punkt hitch cat. II til både front og bagmontering  
Hydraulisk sideforskydning  
Dobbelt modskær  
Slæbesko  
Kraftoverføringsaksel  
Flyt og justerbar rullevalse Ø168  
Udvendig remjustering  
Hammerkniv 14  
Frontbeskyttelse PVC og kæde

### Ekstra udstyr:

Lys og advarselskit kr. 2.650  
Tillæg HD-rotor kr. 5.650  
Lys-udstyr front kr. 5.300  
Kamera-udstyr kr. 6.100  
Klargøring kr. 450

Model	Arb.bredde		Totalbredde		cm	rpm	stk.	kg	Pris
	kW	HP	cm	cm					
BISONTE 220	44-104	60-140	226	249	113 73	1000	20	850	61.200
BISONTE 250	58-104	80-140	257	280	129 89	1000	20	900	68.200
BISONTE 280	66-104	90-140	276	299	138 98	1000	24	1000	75.100
BISONTE 300	74-104	100-140	298	321	149 109	1000	24	1050	79.800

## MODEL BUFALO

Afklip op til Ø12 cm



### Standardudstyr:

Gearbox 1000 rpm med dobbelt friløb  
Dobbelt 3-punkt hitch cat. II og III til både front- og bagmontering  
Hydraulisk sideforskydning  
Dobbelt modskær  
Dobbeltpladet svøb  
HD Rotor  
Slæbesko  
Kraftoverføringsaksel  
Justerbar rullevalse Ø219  
Udvendig remjustering  
Hammerkniv 14  
Frontbeskyttelse PVC og kæde

### Ekstra udstyr:

Lys og advarselskit kr. 2.650  
Lys-udstyr front kr. 5.300  
Kamera-udstyr kr. 6.100  
Klargøring kr. 450

Model	Arb.bredde		Totalbredde		cm	rpm	stk.	kg	Pris
	kW	HP	cm	cm					
BUFALO 250	74-147	100-200	250	270	129 79	1000	26	1210	88.200
BUFALO 280	88-147	120-200	280	299	139 89	1000	28	1300	95.100
BUFALO 300	104-147	140-200	310	330	154 104	1000	30	1360	102.000

# MODEL GIRAFFA M (Girafetta)

Afklip op til Ø4 cm



## Standardudstyr:

Gearbox 540 rpm med friløb  
 Universal 3-punkt hitch cat. I  
 Modskær & Slæbesko  
 Kraftoverføringsaksel  
 Selvrensende justerbar rullelse Ø140  
 Hammerkniv 20  
 Stødsikrings-beskyttelse  
 Udvendig remjustering





## Ekstra udstyr:

Klargøring

kr. 850

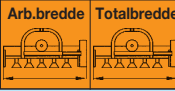

Gearbox udenfor

GIRAFFA M				A	B	C	D	E				Pris	
		Arb.bredde	Totalbredde										cm
Gearbox indeni													
120 S.I.	26-44	35-60	120	133	120	145	55	175	85	540	16	365	47.500
140 S.I.	29-44	40-60	140	155	140	145	55	195	105	540	20	385	49.700
160 S.I.	34-44	45-60	160	175	160	145	55	215	125	540	22	405	51.900
180 S.I.	38-44	50-60	175	190	175	145	55	230	140	540	24	425	54.200
Gearbox udenfor. Se model													
120 S.E.	26-44	35-60	120	156	120	145	30	200	100	540	16	385	50.100
140 S.E.	29-44	40-60	140	176	140	145	30	220	120	540	20	405	52.300
160 S.E.	34-44	45-60	160	196	160	145	30	240	140	540	22	425	54.500
180 S.E.	38-44	50-60	175	211	175	145	30	255	155	540	24	445	56.800

Disse maskiner er specielt lavet til klipning af græs langs vejkanter, grøfter og diger. De klarer nemt alt græs samt buske og krat op til 4 cm tykkelse. Den hydraulisk svingbare arm gør maskinerne meget fleksible, da de kan arbejde sideforskudt og klippe i vinkel fra +90° til -65°. Monteret bag på traktoren kan maskinerne lukkes og arbejder da som en normal centermonteret afpuddser.

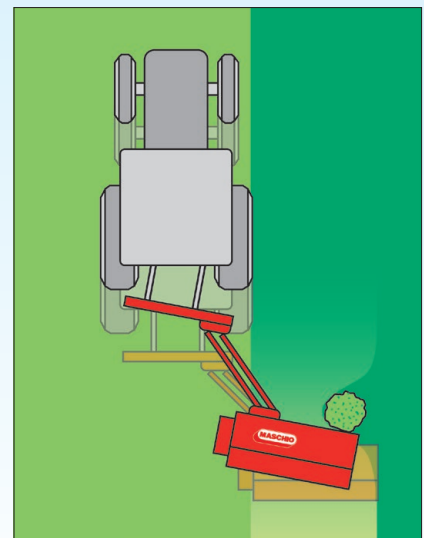
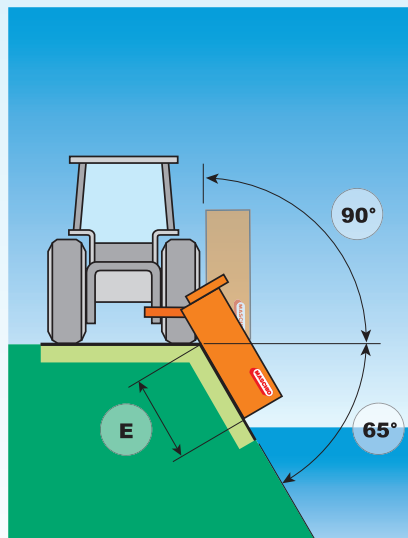
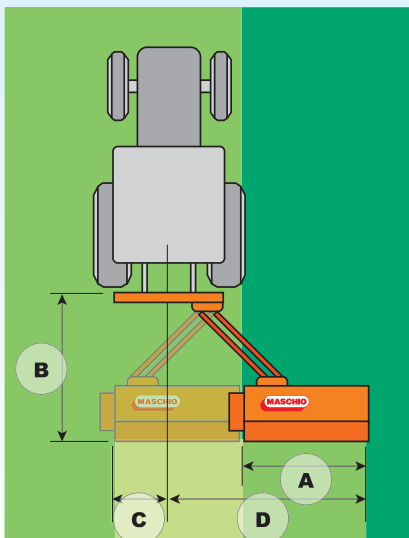

# MODEL GIRAFFA L (ny model)

Afklip op til Ø6 cm



### Standardudstyr:

- Gearbox 540 rpm med friløb
- Universal 3-punkt hitch cat. II
- Modskær & Slæbesko
- Kraftoverføringsaksel
- Selvrensende justerbar rullevalse Ø168
- Hammerkniv 08
- Udvendig remjustering
- Stødsikrings-beskyttelse

### Ekstra udstyr:

- Tillæg vidvinkel PTO kr. 4.550
- Meder til slæbesko, sæt kr. 1.750
- Klargøring kr. 450

GIRAFFA L		Arb.bredde	Totalbredde	A	B	C	D	E				Pris	
		cm	cm	cm					rpm	stk.	kg	ex. moms	
<i>Gearbox indeni</i>													
170 S.I.	30-59	40-80	164	195	164	221	74	236	128	540	20	635	56.500
190 S.I.	30-59	40-80	184	215	184	221	74	256	148	540	22	665	59.400
<i>Gearbox udenfor.</i>													
155 S.E.	30-59	40-80	149	206	187	221	76	259	151	540	16	600	56.400
170 S.E.	30-59	40-80	164	221	202	221	76	274	168	540	20	645	59.300
190 S.E.	30-59	40-80	184	241	222	221	76	294	186	540	22	675	62.100

Disse maskiner er specielt lavet til klipning af græs langs vejkanter, grøfter og diger. De klarer nemt alt græs samt buske og krat op til 6 cm tykkelse. Den hydraulisk svingbare arm gør maskinerne meget fleksible, da de kan arbejde sideforskudt og klippe i vinkel fra +90° til -65°. Monteret bag på traktoren kan maskinerne lukkes og arbejder da som en normal centermonteret afpudser.

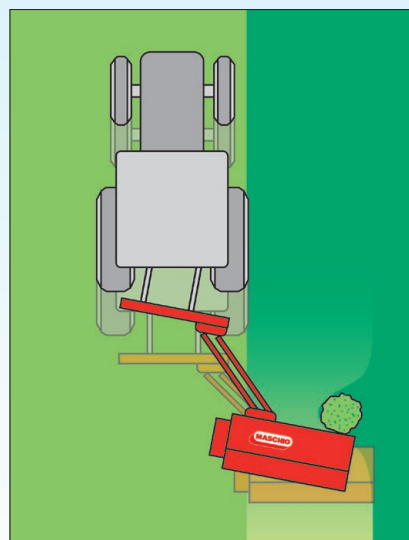
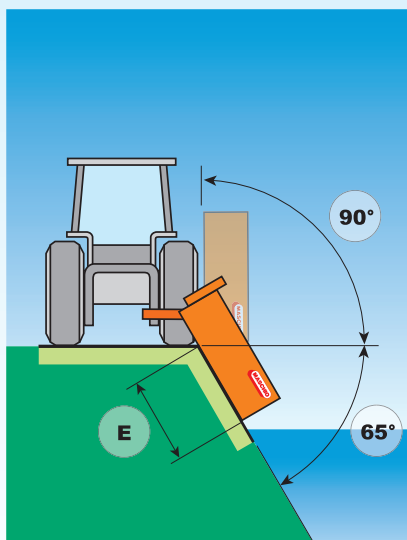
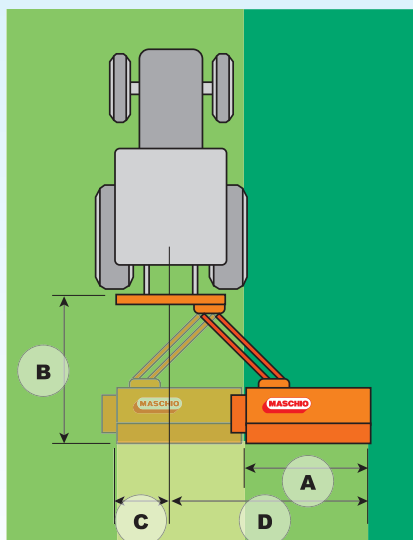

# MODEL GIRAFFA XL (Giraffa)

Afklip op til Ø10 cm

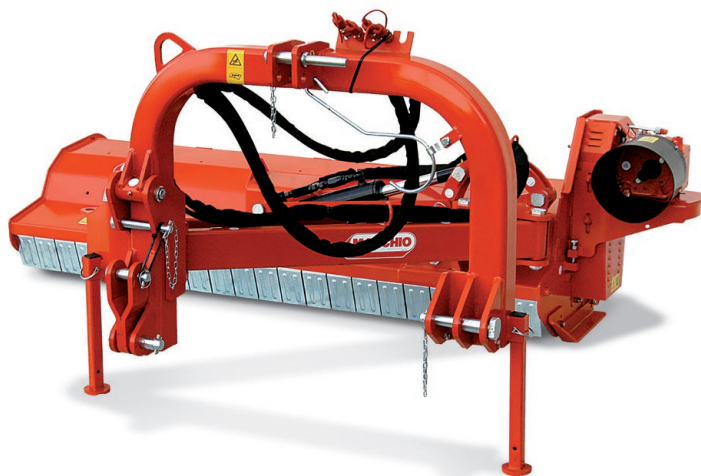





## Standardudstyr:

Gearbox 540 rpm med friløb  
 Universal 3-punkt hitch cat. II-III  
 Modskær  
 Slæbesko  
 Kraftoverføringsaksel  
 Selvrensende justerbar rullevalse Ø168  
 Hammerkniv 14  
 Udvendig remjustering  
 Stødsikrings-beskyttelse

## Ekstra udstyr:

Tillæg vidvinkel PTO kr. 4.550  
 Tillæg venstre ophængt version kr. 2.350  
 Dobbelt svøb m/ekstra modskær kr. 4.450  
 Meder til slæbesko, sæt kr. 1.800  
 Tillæg HD spiral-rotor kr. 3.450  
 Klargøring kr. 450

GIRAFFA XL		Arb.bredde Totalbredde		A	B	C	D	E				Pris	
		cm	cm										cm
<b>Gearbox indeni</b>													
160 S.I.	38-81	50-110	157	177	157	170	80	221	122	540	16	716	61.900
185 S.I.	44-81	60-110	190	210	190	170	80	251	155	540	20	776	65.900
210 S.I.	51-81	70-110	212	232	212	170	80	276	177	540	22	792	69.900
<b>Gearbox udenfor. SE model</b>													
160 S.E.	38-81	50-110	157	198	157	170	35	265	150	540	16	720	65.900
185 S.E.	44-81	60-110	190	231	190	170	35	295	183	540	20	780	70.100
210 S.E.	51-81	70-110	212	253	212	170	35	320	205	540	22	810	74.100

Disse maskiner er specielt lavet til klipning af græs langs vejkanter, grøfter og diger. De klarer nemt alt græs samt buske og krat op til 10 cm tykkelse. Den hydraulisk svingbare arm gør maskinerne meget fleksible, da de kan arbejde sideforskudt og klippe i vinkel fra +90° til -65°. Monteret bag på traktoren kan maskinerne lukkes og arbejder da som en normal centermonteret afpuddser.

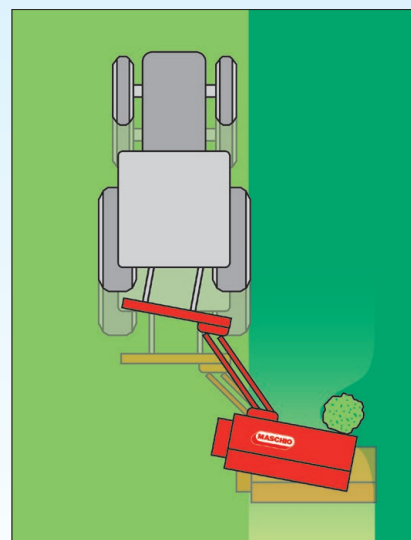
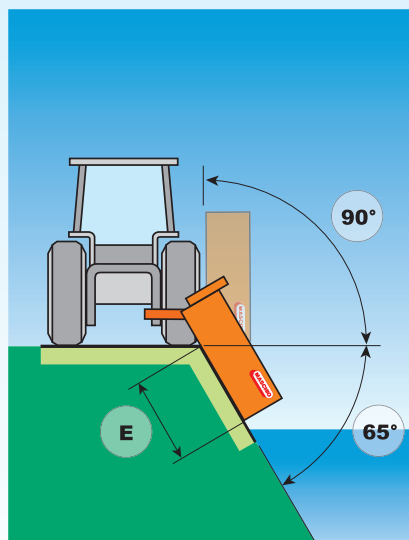
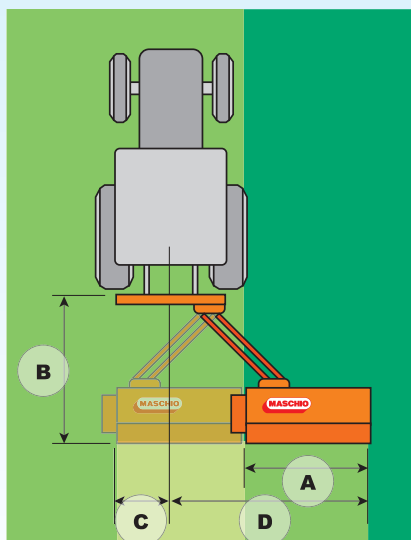



# MODEL GIRAFFA XXL (Giraffona)

Afklip op til Ø12 cm







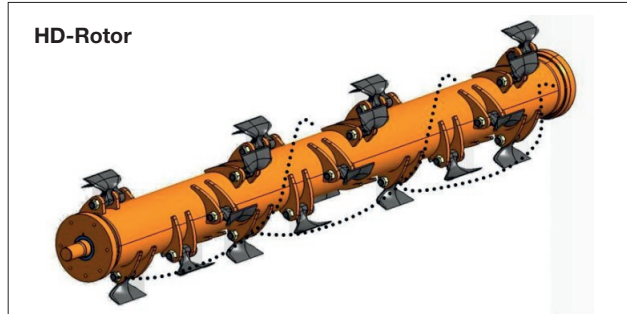

## Standardudstyr:

Gearbox 540 rpm med friløb  
 Universal 3-punkt hitch cat. II-III  
 Dobbelt modskær  
 Dobbeltpladet svøb  
 Slæbesko  
 Kraftoverføringsaksel med vidvinkel  
 Flyt- og justerbar rullevalse Ø168  
 Hammerkniv 14  
 Udvendig remjustering  
 Stødsikrings-beskyttelse

## Ekstra udstyr:

Tillæg venstre ophængt version kr. 3.350  
 Tillæg HD Rotor kr. 5.650  
 Meder til slæbesko, sæt kr. 1.800  
 Lys og advarselskit kr. 2.650  
 Klargøring kr. 450



GIRAFFA XXL				A	B	C	D	E				Pris	
Heavy Duty model	KW	HP	cm	cm	cm					rpm	stk.	kg	ex. moms
MODEL 210	90-147	120-200	210	264	210	238	50	318	200	540	16	1075	102.000
MODEL 230	98-147	130-200	226	278	226	238	50	334	216	540	20	1110	105.000
MODEL 260	105-147	140-200	257	308	257	238	50	365	247	540	20	1220	109.000

Disse maskiner er specielt lavet til klipping af græs langs vejkanter, grøfter og diger. De klarer nemt alt græs samt buske og krat op til 12 cm tykkelse. Den hydraulisk svingbare arm gør maskinerne meget fleksible, da de kan arbejde sideforskudt og klippe i vinkel fra +90° til -65°. Monteret bag på traktoren kan maskinerne lukkes og arbejder da som en normal centermonteret afpudser.

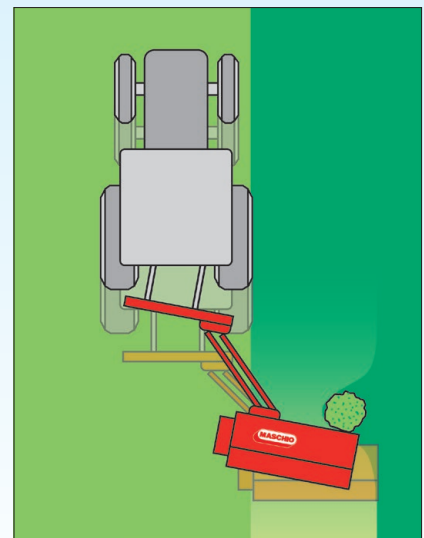
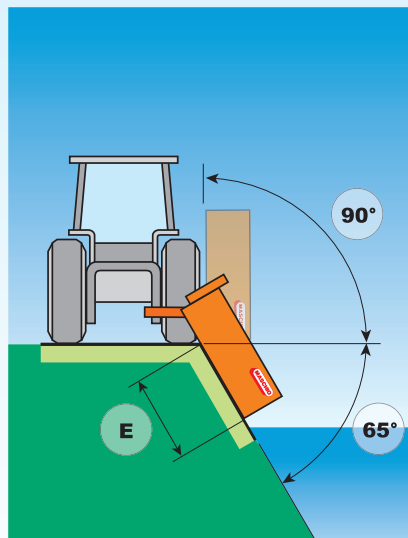
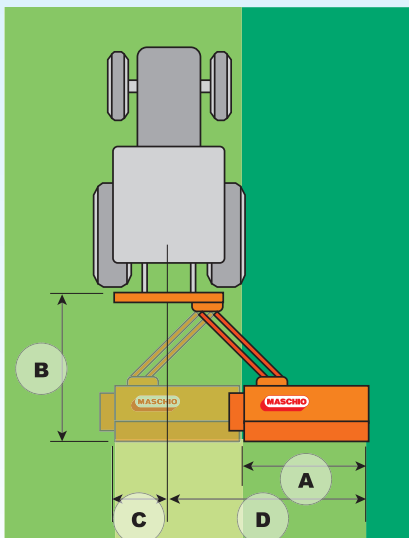

# Hegns- og rabatklipper

Bagmonterede rabatklippere med klippehøjde/rækkevidde fra 380 cm op til 930 cm. Det ophængte klippehovede på den hydrauliske arm gør disse maskiner til et enestående redskab til vedligeholdelse af sø og å-bredder, grøfter, diger og øvrige græsarealer.

Engelske specialbrochurer forefindes.

## Margherita



## Cristina



## Martina



## Palma



## Katia



## Lara



## Camilla



### Standardudstyr:







Flydende klippehovede med oliemotor.  
Oliekøler.

Hydraulisk styring via ventilsæt med kabeltræk.  
3-punkts ophæng med stabilisator.  
Kraftoverføringsaksel.

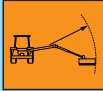
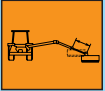
### Ekstra udstyr:

Lysudstyr	kr. 6.350
Elektrisk joy-stick On/Off	kr. 30.800
Proportional el-servo joy-stick	kr. 45.800
Fingerklipper 160 (max. 2,5 cm)	kr. 33.500
Fingerklipper 180 (max. 5 cm)	kr. 64.600
Fingerklipper 200 (max. 10 cm)	kr. 86.300
Grøftefræser, 50 cm	kr. 36.500
Grøftefræser, 60 cm	kr. 40.500
Hurtigskift til klippehoved	kr. 4.450

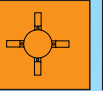
Er de specifikationer, du ønsker, ikke nævnt, så forhør.  
Der findes andre modeller.

Model									HP max hyd.motor	Pris
	Klippehøjde klippevidde	Klippe- hoved	Egenvægt kg	Min. traktor vægt i kg	HP	Liter	Rotor (rpm)	Rotor Ø periferisk		ex. moms
<b>Margherita 380</b>	380	90	450	1600	25	75	3000	360	20	95.600
<b>Cristina 460</b>	460	100	620	2000	40	120	3000	360	40	110.800
<b>Cristina 560</b>	560	100	665	2500	60	120	3000	360	40	119.900
<b>Martina 500</b>	500	120	1100	2500	60	170	3000	430	40	144.300
<b>Martina 600 T</b>	640	120	1330	3000	65	170	3000	430	40	178.200
<b>Palma 500</b>	505	120	1000	2500	60	170	3000	430	40	170.900
<b>Palma 600</b>	610	120	1070	3000	60	170	3000	430	40	175.400
<b>Palma 720 T</b>	745	120	1160	3500	80	200	3000	430	58	220.900
<b>Camilla 600 T</b>	610	120	1250	3500	80	200	3000	430	58	218.900
<b>Katia 550</b>	540	125	1040	3500	80	200	3000	450	58	208.500
<b>Katia 650</b>	625	125	1130	3800	100	220	3000	450	58	249.900
<b>Lara 930 T</b>	930	150	2120	6000	100	220	3000	450	56	339.600

Maschio fabrikken, der er beliggende i det nordlige Italien, er Italiens største, og en af verdens førende producenter af jordbearbejdningsmaskiner. Foruden afpudsere laver Maschio også fræsere, rækkefræsere, knivfræsere, tallerkenharver og rotorharver i mange størrelser og modeller.



Grøftefræser



Fingerklipper



## MODEL TORNADO

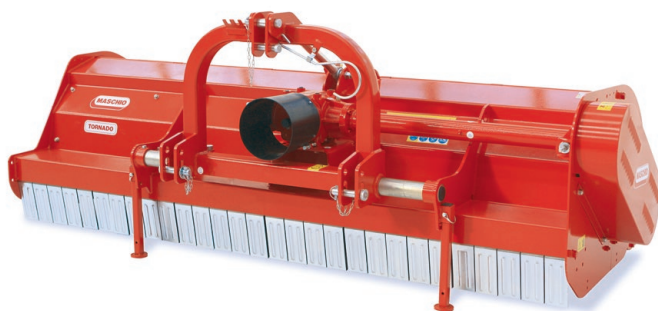

### Standardudstyr:

Gearbox 540 rpm med friløb  
 Universal 3-punkt hitch cat. II  
 Modskær  
 Oplukkelig bagklap  
 Justerbar rullevalse Ø219  
 Kraftoverføringsaksel  
 Udvendig remjustering  
 Hammer slagle 16  
 Mekanisk sideregulering

### Ekstra udstyr:

Slæbesko, sæt 99600529 kr. 2.100  
 Tillæg for styrehjul i stedet for rullevalse kr. 6.000  
 Tillæg for hyd. sideforskydning kr. 3.200  
 Dobbelt Chassis m/ekstra modskær kr. 4.900  
 Lys og advarselskit kr. 2.850  
 Klargøring kr. 400

Model	Traktor		Arb.bredde		Totalbredde		Klapp	Rullevalse	Akse	Klapp	Pris
	kW	HP	cm	cm	cm	cm					
TORNADO 250	51-110	70-150	250	270	128 98	122 152	540	26	960	63.600	
TORNADO 280	59-110	80-150	280	300	140 110	140 170	540	28	1035	69.100	
TORNADO 310	66-110	90-150	310	330	172 142	138 168	540	32	1125	74.600	

## MODEL LEOPARD



### Standardudstyr:

Gearbox 540 rpm med friløb  
 Universal 3-punkt hitch cat. II  
 Modskær  
 Oplukkelig bagklap  
 Justerbar rullevalse Ø219  
 Kraftoverføringsaksel  
 Udvendig remjustering  
 Hammer slagle 16  
 Træk i begge sider

### Ekstra udstyr:

Slæbesko, sæt 99600529 kr. 2.100  
 Tillæg for styrehjul i stedet for rullevalse kr. 8.350  
 Dobbelt Chassis m/ekstra modskær kr. 7.800  
 Lys og advarselskit kr. 2.850  
 Klargøring kr. 400

Model	Traktor		Arb.bredde		Totalbredde		Klapp	Rullevalse	Akse	Klapp	Pris
	kW	HP	cm	cm	cm	cm					
LEOPARD 320	102-147	140-200	320	349	160	160	1000	34	1356	102.900	

# MODEL GEMELLA



### Standardudstyr:

Gearbox 1000 rpm med friløb  
 Universal 3-punkt hitch cat. II og III  
 Oplukkelig bagklap  
 Hydraulisk opklappelig (240 cm)  
 Modskær  
 Transportsikring samt lys  
 Justerbar rullevalse Ø219  
 Kraftoverføringsaksel Z6  
 Udvendig remjustering  
 Hammer slagle 16  
 Justerbare slæbesko  
 Midtkniv for minimering af midtstribe







Monteret med hjul

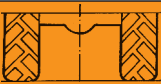

Opklap for transport

### Ekstra udstyr:

Styrehjul i stedet for rullevalse - 2 sæt kr. 16.600  
 Dobbelt Chassis m/ekstra modskær kr. 9.600  
 Stribeklipper kr. 38.600  
 Klargøring kr. 650

Model		Arb.bredde	Totalbredde					Pris	
	kW	HP	cm	cm	cm	rpm	stk.	kg	ex. moms
GEMELLA 470	88-220	120-300	465	502	235	1000	48	2500	216.300
GEMELLA 620	110-220	150-300	620	657	360	1000	64	2925	235.200

Importør for Danmark:

# MO implements

MO Implements A/S • Ulvevej 24 C • 7800 Skive  
 Telefon: 96 14 04 44  
 E-mail: mo@mo-i.dk • Internet: www.mo-i.dk



Forhandler: